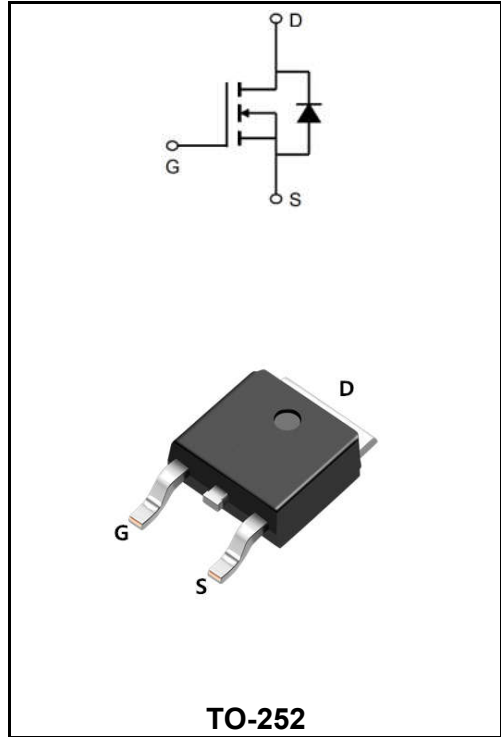


**30V N-CHANNEL ENHANCEMENT MODE MOSFET**

**MAIN CHARACTERISTICS**

<b>I<sub>D</sub></b>	150A
<b>V<sub>DSS</sub></b>	30V
<b>R<sub>DS(on)-typ</sub>(@V<sub>GS</sub>=10V)</b>	< 3mΩ ( <b>Type:2.2 mΩ</b> )



**Application**

- ◆ Battery protection
- ◆ Load switch
- ◆ Uninterruptible power supply

**Product Specification Classification**

Part Number	Package	Marking	Pack
YFW150N03AD	TO-252	YFW 150N03AD XXXXX	2500PCS/Tape

**Maximum Ratings at T<sub>c</sub>=25°C unless otherwise specified**

Characteristics	Symbols	Value	Units
Drain-Source Voltage	<b>V<sub>DS</sub></b>	30	<b>V</b>
Gate - Source Voltage	<b>V<sub>GS</sub></b>	±20	<b>V</b>
Continuous Drain Current, V <sub>GS</sub> @ 10V <sup>1,6</sup> @T <sub>c</sub> =25°C	<b>I<sub>D</sub></b>	155	<b>A</b>
Continuous Drain Current, V <sub>GS</sub> @ 10V <sup>1,6</sup> @T <sub>c</sub> =100°C	<b>I<sub>D</sub></b>	110	<b>A</b>
Pulsed Drain Current <sup>2</sup>	<b>I<sub>DM</sub></b>	450	<b>A</b>
Single Pulse Avalanche Energy <sup>3</sup>	<b>E<sub>AS</sub></b>	246	<b>mJ</b>
Avalanche Current	<b>I<sub>AS</sub></b>	70.2	<b>A</b>
Total Power Dissipation <sup>4</sup> @T <sub>c</sub> =25°C	<b>P<sub>D</sub></b>	89.3	<b>W</b>
Storage Temperature Range	<b>T<sub>STG</sub></b>	-55 to +175	<b>°C</b>
Operating Junction Temperature Range	<b>T<sub>J</sub></b>	-55 to +175	<b>°C</b>
Thermal Resistance, Junction-Ambient <sup>1</sup>	<b>R<sub>θJA</sub></b>	62	<b>°C/W</b>
Thermal Resistance Junction-Case <sup>1</sup>	<b>R<sub>θJC</sub></b>	1.4	<b>°C/W</b>

**Maximum Ratings at Tc=25°C unless otherwise specified**

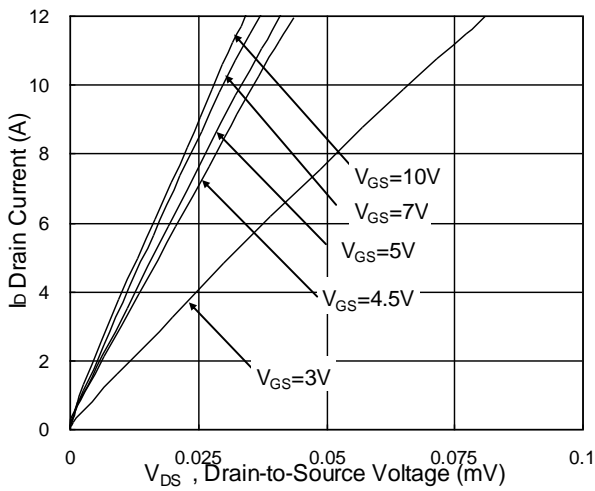
Characteristics	Test Condition	Symbols	Min	Typ	Max	Units
Drain-Source Breakdown Voltage	$V_{GS}=0V, I_D=250\mu A$	$BV_{DSS}$	30	-	-	V
BVDSS Temperature Coefficient	Reference to 25°C, $I_D=1mA$	$\Delta BV_{DSS}/\Delta T_J$	-	0.022	-	V/°C
Static Drain-Source On-Resistance <sup>2</sup>	$V_{GS}=10V, I_D=30A$	$R_{DS(ON)}$	-	2.2	3	mΩ
	$V_{GS}=4.5V, I_D=15A$		-	3.2	4	
Gate -Threshold Voltage	$V_{DS}=V_{GS}, I_D=250\mu A$	$V_{GS(th)}$	1	-	2.5	V
VGS(th) Temperature Coefficient		$\Delta V_{GS(th)}$	-	-6.1	-	mV/°C
Drain-Source Leakage Current	$V_{DS}=24V, V_{GS}=0V, T_J=25^\circ C$	$I_{DSS}$	-	-	2	μA
	$V_{DS}=24V, V_{GS}=0V, T_J=55^\circ C$		-	-	10	
Gate-Source Leakage Current	$V_{GS}=\pm 20V, V_{DS}=0V$	$I_{GSS}$	-	-	±100	nA
Forward Transconductance	$V_{DS}=5V, I_D=30A$	$g_{FS}$	-	60	-	S
Gate Resistance	$V_{DS}=0V, V_{GS}=0V, f=1MHz$	$R_g$	-	0.9	-	
Total Gate Charge(4.5V)	$V_{DS}=15V$ $V_{GS}=10V$ $I_D=15A$	$Q_g$	-	56.9	-	nC
Gate-Source Charge		$Q_{gs}$	-	13.8	-	
Gate-Drain Charge		$Q_{gd}$	-	23.5	-	
Turn-on delay time	$V_{DD}=15V$ $V_{GS}=10V$ $R_G=3.3$ $I_D=1A$	$t_{d(on)}$	-	20.1	-	ns
Rise Time		$T_r$	-	6.3	-	
Turn-Off Delay Time		$t_{d(OFF)}$	-	124.6	-	
Fall Time		$t_f$	-	15.8	-	
Input Capacitance	$V_{DS}=15V$ $V_{GS}=0V$ $f=1.0MHz$	$C_{iss}$	-	5935	-	pF
Output Capacitance		$C_{oss}$	-	725	-	
Reverse Transfer Capacitance		$C_{rss}$	-	538	-	
Continuous Source Current <sup>1,5</sup>	$V_G=V_D=0V, \text{Force Current}$	$I_S$	-	-	155	A
Pulsed Source Current <sup>2,5</sup>		$I_{SM}$	-	-	310	A
Diode Forward Voltage <sup>2</sup>	$V_{GS}=0V, I_S=1A, T_J=25^\circ C$	$V_{SD}$	-	-	1.2	V

Note :

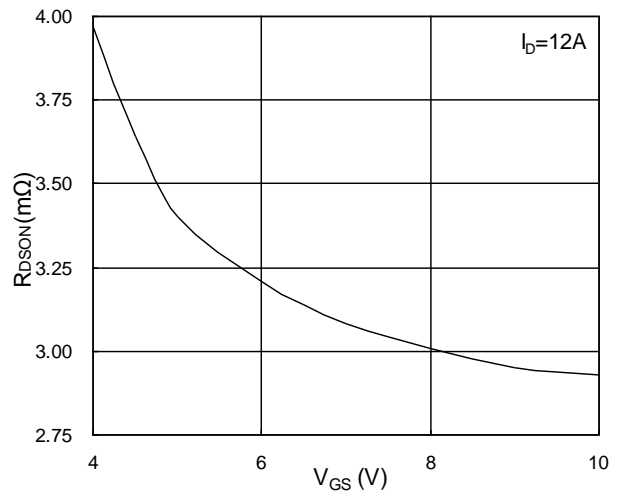
1. The data tested by surface mounted on a 1 inch<sup>2</sup> FR-4 board with 2OZ copper.
2. The data tested by pulsed, pulse width  $\leq 300\mu s$ , duty cycle  $\leq 2\%$
3. The EAS data shows Max. rating. The test condition is  $V_{DD}=25V, V_{GS}=10V, L=0.1mH, I_{AS}=70.2A$
4. The power dissipation is limited by 150°C junction temperature
5. The data is theoretically the same as  $I_D$  and  $I_{DM}$ , in real applications, should be limited by total power dissipation.
6. Package limitation current is 85A.

**Ratings and Characteristic Curves**

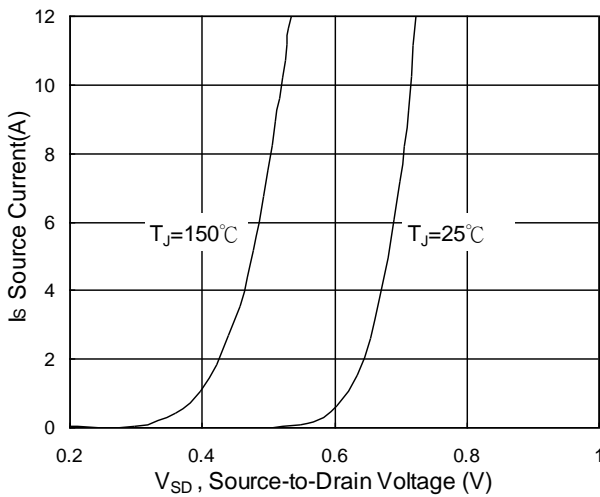
**Typical Characteristics**



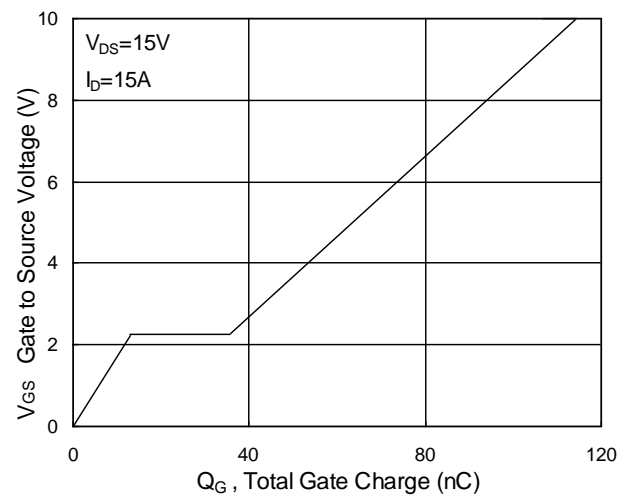
**Fig.1 Typical Output Characteristics**



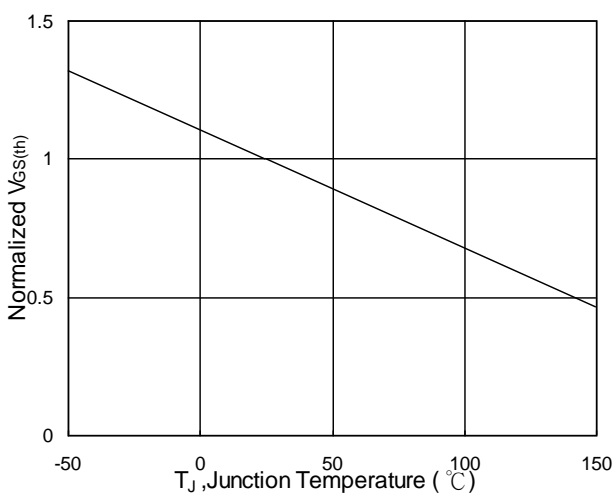
**Fig.2 On-Resistance v.s Gate-Source**



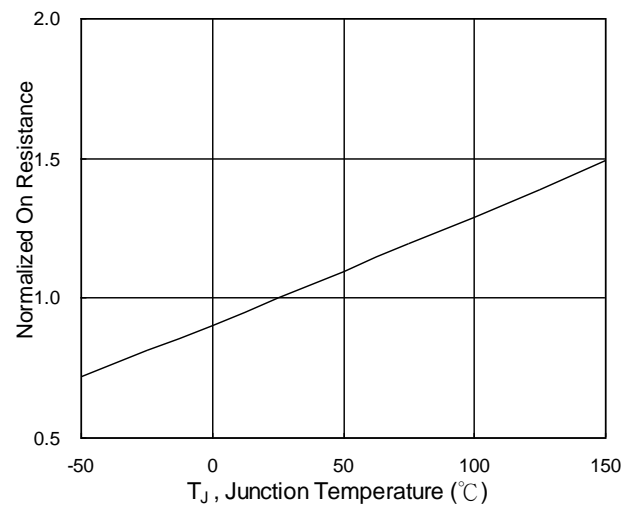
**Fig.3 Forward Characteristics of Reverse**



**Fig.4 Gate-Charge Characteristics**

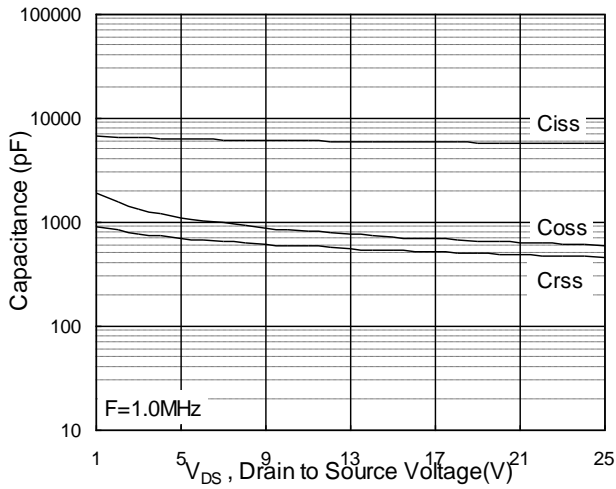


**Fig.5 Normalized  $V_{GS(th)}$  v.s  $T_J$**

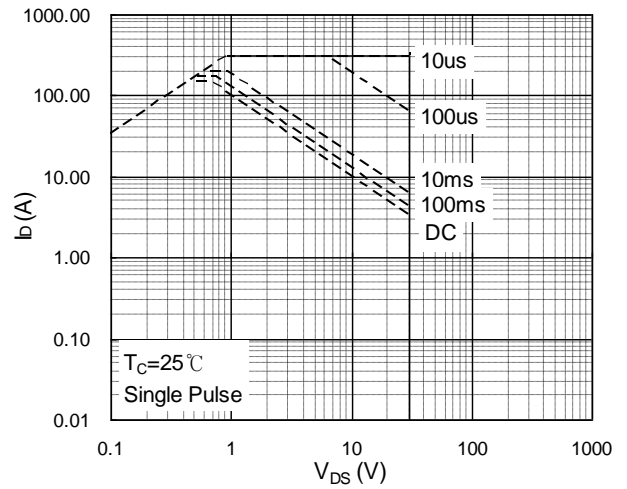


**Fig.6 Normalized  $R_{DS(on)}$  v.s  $T_J$**

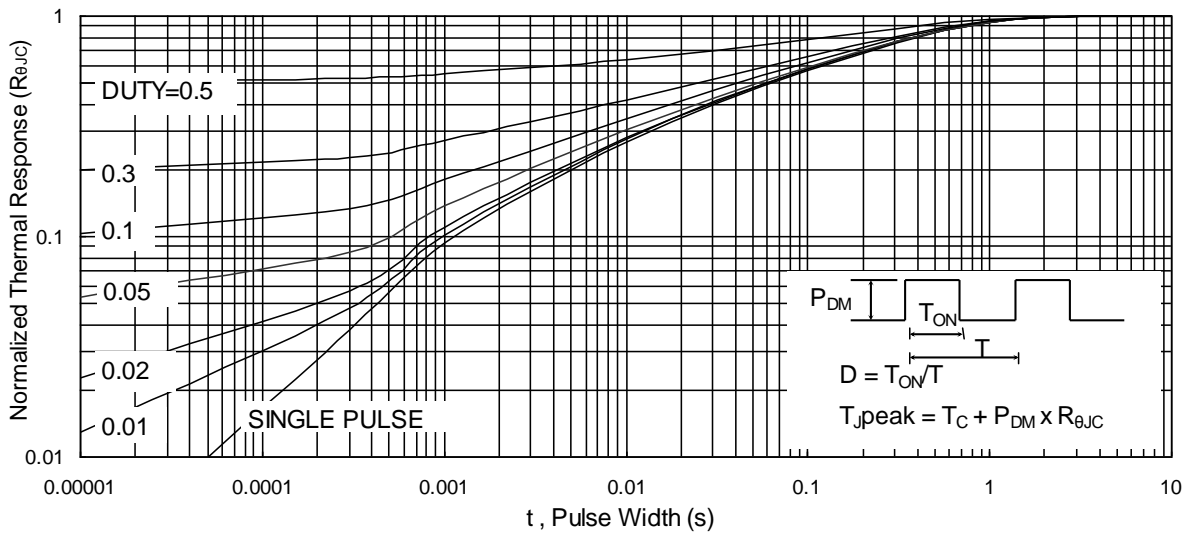
**Ratings and Characteristic Curves**



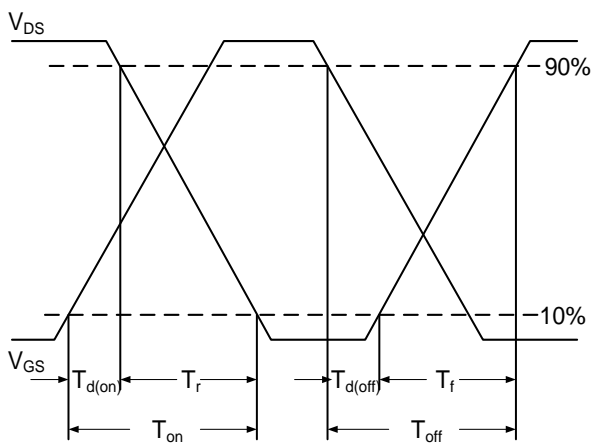
**Fig.7 Capacitance**



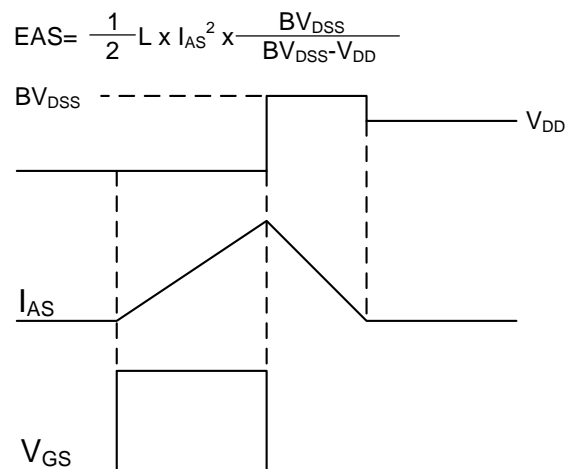
**Fig.8 Safe Operating Area**



**Fig.9 Normalized Maximum Transient Thermal Impedance**



**Fig.10 Switching Time Waveform**



**Fig.11 Unclamped Inductive Waveform**

Package Outline Dimensions Millimeters

TO-252

Dim.	Min.	Typ.	Max.
A	2.10	-	2.50
A2	0	-	0.10
B	0.66	-	0.86
B2	5.18	-	5.48
C	0.40	-	0.60
C2	0.44	-	0.58
D	5.90	-	6.30
D1	5.30REF		
E	6.40	-	6.80
E1	4.63	-	-
G	4.47	-	4.67
H	9.50	-	10.70
L	1.09	-	1.21
L2	1.35	-	1.65
V1	-	7°	-
V2	0°	-	6°
All Dimensions in millimeter			

