

Surface Mount Fast Recovery Rectifiers

Reverse Voltage - 50 to 1000 V

Forward Current - 1 A

FEATURES

- ◆ For surface mounted applications
- ◆ Low profile package
- ◆ Glass Passivated Chip Junction
- ◆ Easy to pick and place
- ◆ Fast reverse recovery time
- ◆ Lead free in comply with EU RoHS 2011/65/EU directives



MECHANICAL DATA

- ◆ Case: SOD-123FL
- ◆ Terminals: Solderable per MIL-STD-750, Method 2026
- ◆ Approx. Weight: 15mg / 0.00053oz

Absolute Maximum Ratings and characteristics

Ratings at 25 °C ambient temperature unless otherwise specified.
Single phase half-wave 60 Hz, resistive or inductive load, for capacitive load current derate by 20 %.

Pinning

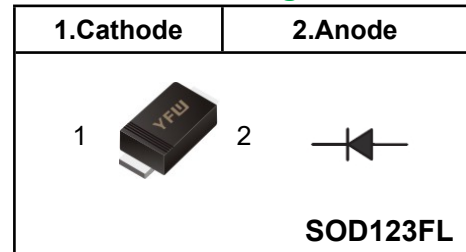

Marking Code

| | | |
|--------|----|-----|
| FR101W | F1 | F1A |
| FR102W | F2 | F1B |
| FR103W | F3 | F1D |
| FR104W | F4 | F1G |
| FR105W | F5 | F1J |
| FR106W | F6 | F1K |
| FR107W | F7 | F1M |

| Parameter | Symbols | FR101W | FR102W | FR103W | FR104W | FR105W | FR106W | FR107W | Units |
|--|-----------------|------------|--------|--------|--------|--------|--------|--------|--------------------|
| Maximum Repetitive Peak Reverse Voltage | V_{RRM} | 50 | 100 | 200 | 400 | 600 | 800 | 1000 | V |
| Maximum RMS voltage | V_{RMS} | 35 | 70 | 140 | 280 | 420 | 560 | 700 | V |
| Maximum DC Blocking Voltage | V_{DC} | 50 | 100 | 200 | 400 | 600 | 800 | 1000 | V |
| Maximum Average Forward Rectified Current at $T_c = 125\text{ }^\circ\text{C}$ | $I_{F(AV)}$ | 1 | | | | | | | A |
| Peak Forward Surge Current 8.3 ms Single Half Sine Wave Superimposed on Rated Load | I_{FSM} | 30 | | | | | | | A |
| Maximum Instantaneous Forward Voltage at 1 A | V_F | 1.3 | | | | | | | V |
| Maximum DC Reverse Current $T_a = 25\text{ }^\circ\text{C}$ at Rated DC Blocking Voltage $T_a = 125\text{ }^\circ\text{C}$ | I_R | 5 100 | | | | | | | μA |
| Typical Junction Capacitance at $V_R=4\text{V}, f=1\text{MHz}$ | C_j | 15 | | | | | | | pF |
| Maximum Reverse Recovery Time ⁽¹⁾ | T_{rr} | 150 | | | | 250 | 500 | | nS |
| Typical Thermal Resistance ⁽²⁾ | $R_{\theta JA}$ | 85 | | | | | | | $^\circ\text{C/W}$ |
| Operating and Storage Temperature Range | T_j, T_{stg} | -55 ~ +150 | | | | | | | $^\circ\text{C}$ |

(1) Measured with $I_F=0.5\text{A}, I_R=1\text{A}, I_n=0.25\text{A}$

(2) P.C.B. mounted with 2.0" X 2.0" (5 X 5 cm) copper pad areas.

Fig.1 Forward Current Derating Curve

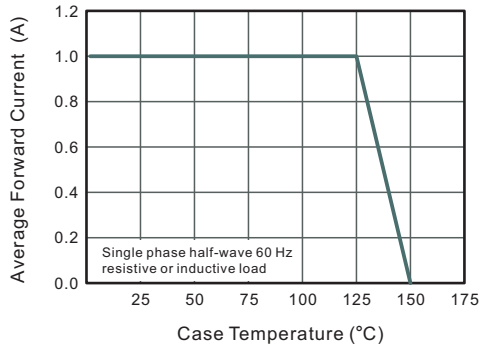

Fig.2 Typical Reverse Characteristics

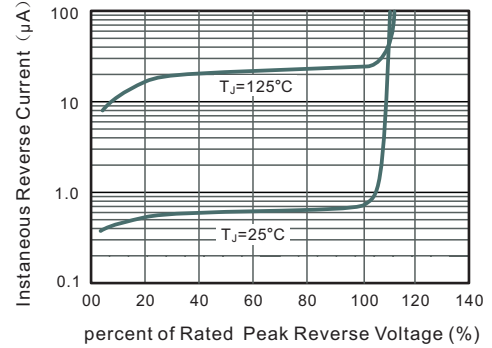

Fig.3 Typical Instantaneous Forward Characteristics

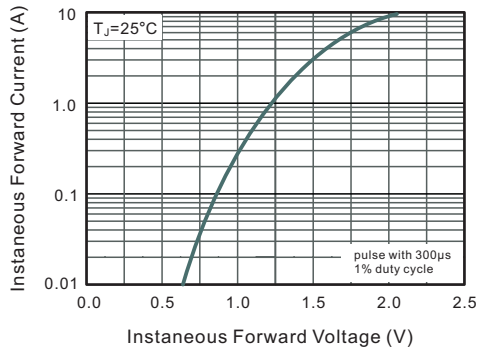

Fig.4 Typical Junction Capacitance

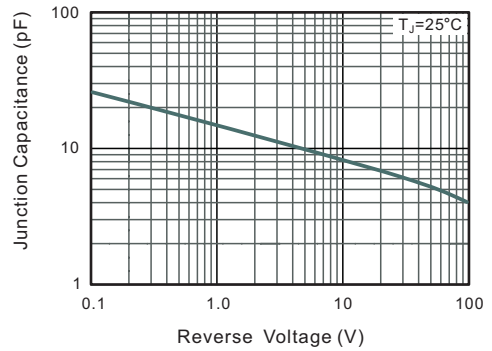
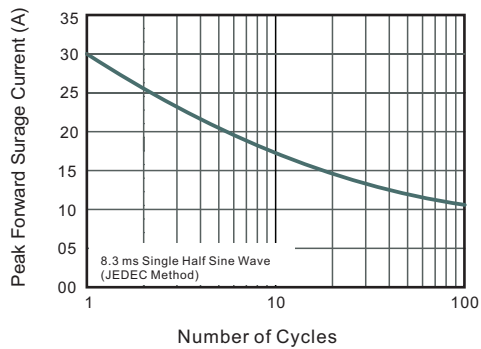
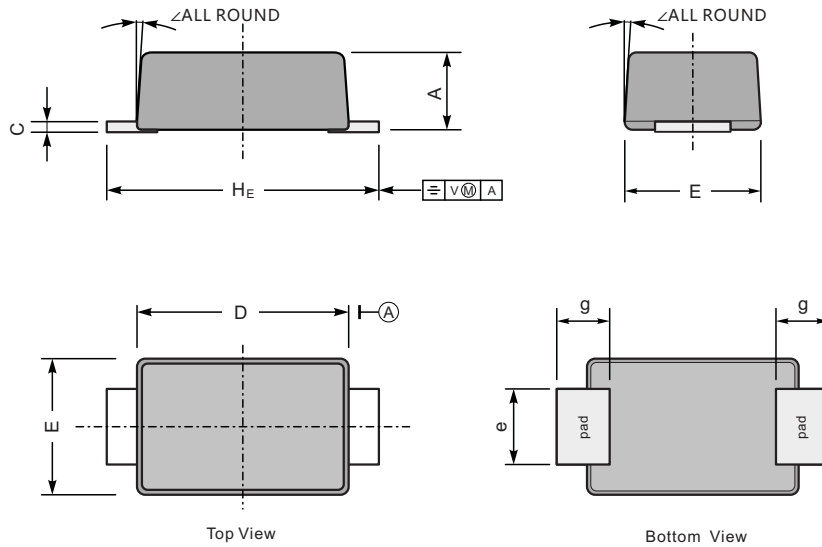

Fig.5 Maximum Non-Repetitive Peak Forward Surge Current



Package Outline SOD-123FL

Plastic surface mounted package; 2 leads



| UNIT | | A | C | D | E | e | g | H _E | \angle |
|------|-----|-----|------|-----|-----|-----|-----|----------------|----------|
| mm | max | 1.3 | 0.20 | 2.9 | 1.9 | 1.1 | 0.9 | 3.8 | 7° |
| | min | 0.9 | 0.12 | 2.6 | 1.7 | 0.8 | 0.7 | 3.5 | |
| mil | max | 43 | 7.9 | 114 | 75 | 43 | 35 | 150 | |
| | min | 35 | 4.7 | 102 | 67 | 31 | 28 | 138 | |

The recommended mounting pad size



Unit: $\frac{\text{mm}}{\text{mil}}$

Summary of Packing Options

| Package | Packing Description | Packing Quantity | Industry Standard |
|-----------|---------------------|------------------|-------------------|
| SOD-123FL | Tape/Reel, 13" reel | 10000 | EIA-481-1 |
| | Tape/Reel, 7" reel | 3000 | EIA-481-1 |